

ELECTROSTATIC SENSITIVE DEVICE
OBSERVE HANDLING PRECAUTIONS

MITSUBISHI RF POWER MOS FET

RD16HHF1

RoHS Compliance, Silicon MOSFET Power Transistor 30MHz,16W

DESCRIPTION

RD16HHF1 is a MOS FET type transistor specifically designed for HF RF power amplifiers applications.

FEATURES

High power gain:
Pout>16W, Gp>16dB @Vdd=12.5V,f=30MHz

APPLICATION

For output stage of high power amplifiers in HF band mobile radio sets.

RoHS COMPLIANT

RD16HHF1-101 is a RoHS compliant products. RoHS compliance is indicate by the letter "G" after the lot marking.

This product include the lead in high melting temperature type solders.

How ever,it applicable to the following exceptions of RoHS Directions.

- 1.Lead in high melting temperature type solders(i.e.tin-lead solder alloys containing more than85% lead.)

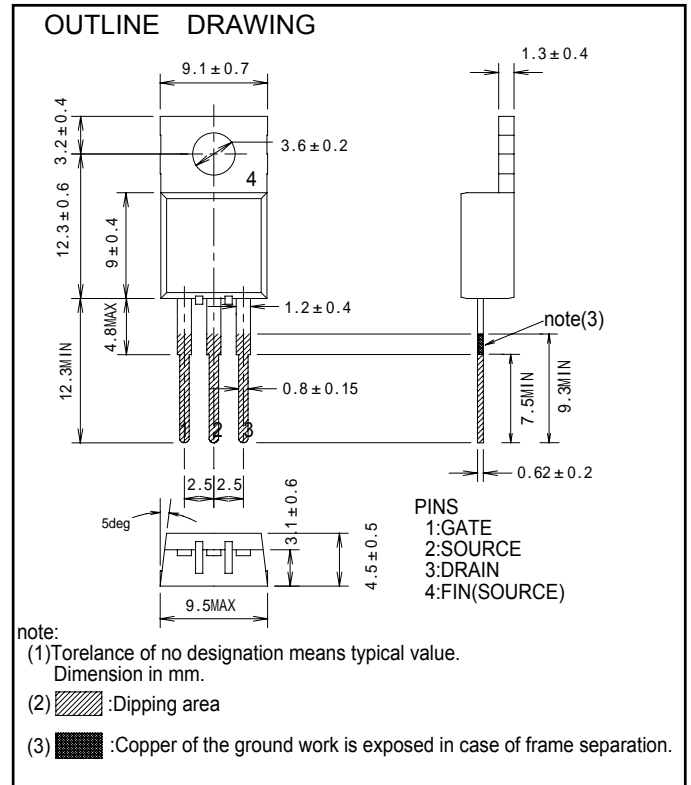

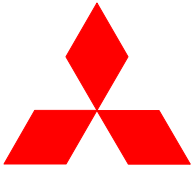

ELECTROSTATIC SENSITIVE DEVICE
OBSERVE HANDLING PRECAUTIONS

MITSUBISHI RF POWER MOS FET

RD16HHF1

RoHS Compliance, Silicon MOSFET Power Transistor 30MHz,16W

ABSOLUTE MAXIMUM RATINGS

(T_c=25°C UNLESS OTHERWISE NOTED)

SYMBOL	PARAMETER	CONDITIONS	RATINGS	UNIT
V _{DSS}	Drain to source voltage	V _{gs} =0V	50	V
V _{GSS}	Gate to source voltage	V _{ds} =0V	+/- 20	V
P _{ch}	Channel dissipation	T _c =25°C	56.8	W
P _{in}	Input power	Z _g =Z _l =50Ω	0.8	W
I _D	Drain to source current	-	5	A
T _{ch}	Channel temperature	-	150	°C
T _{stg}	Storage temperature	-	-40 to +150	°C
R _{th j-c}	Thermal resistance	junction to case	2.2	°C/W

Note 1: Above parameters are guaranteed independently.

ELECTRICAL CHARACTERISTICS (T_c=25°C , UNLESS OTHERWISE NOTED)

SYMBOL	PARAMETER	CONDITIONS	LIMITS			UNIT
			MIN	TYP	MAX.	
I _{DSS}	Zero gate voltage drain current	V _{DS} =17V, V _{GS} =0V	-	-	10	μA
I _{GSS}	Gate to source leak current	V _{GS} =10V, V _{DS} =0V	-	-	1	μA
V _{TH}	Gate threshold voltage	V _{DS} =12V, I _{DS} =1mA	1.7	-	4.7	V
P _{out}	Output power	V _{DD} =12.5V, P _{in} =0.4W, f=30MHz, I _{dq} =0.5A	16	19	-	W
η _D	Drain efficiency	f=30MHz, I _{dq} =0.5A	55	65	-	%
	Load VSWR tolerance	V _{DD} =15.2V, P _o =16W(Pin Control) f=30MHz, I _{dq} =0.5A, Z _g =50Ω Load VSWR=20:1(All Phase)	No destroy			-

Note : Above parameters , ratings , limits and conditions are subject to change.

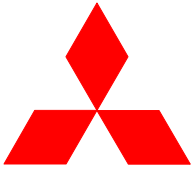

ELECTROSTATIC SENSITIVE DEVICE
OBSERVE HANDLING PRECAUTIONS

MITSUBISHI RF POWER MOS FET

RD16HHF1

RoHS Compliance, Silicon MOSFET Power Transistor 30MHz,16W

TYPICAL CHARACTERISTICS

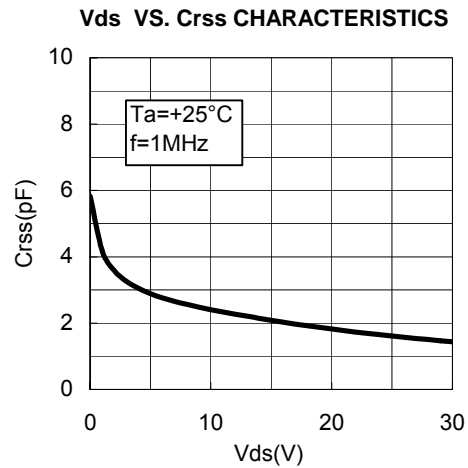
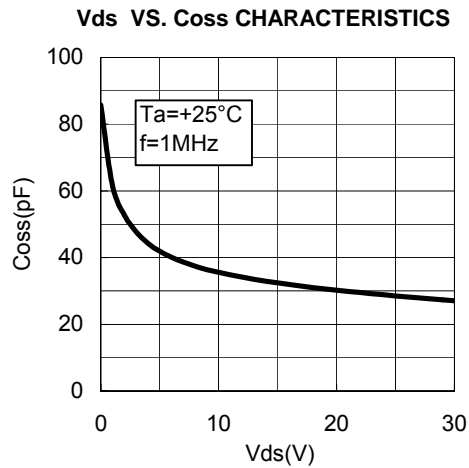
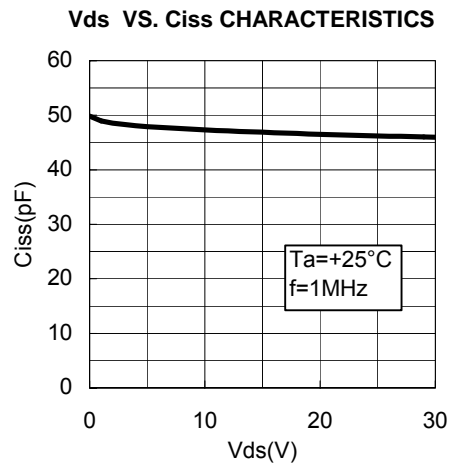
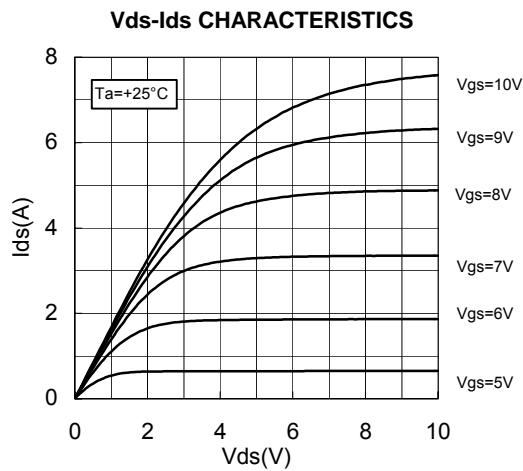
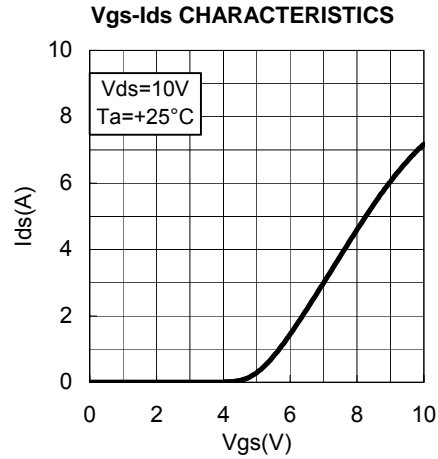
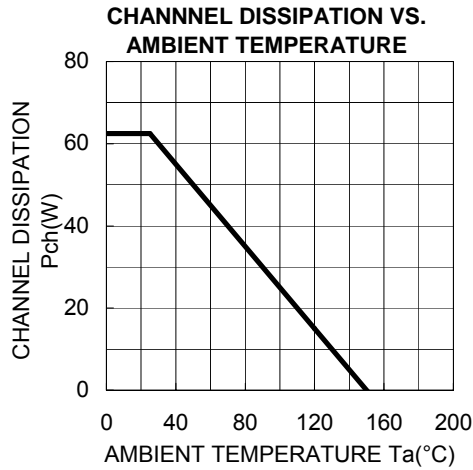



ELECTROSTATIC SENSITIVE DEVICE
OBSERVE HANDLING PRECAUTIONS

MITSUBISHI RF POWER MOS FET

RD16HHF1

RoHS Compliance, Silicon MOSFET Power Transistor 30MHz,16W

TYPICAL CHARACTERISTICS

Pin-Po CHARACTERISTICS

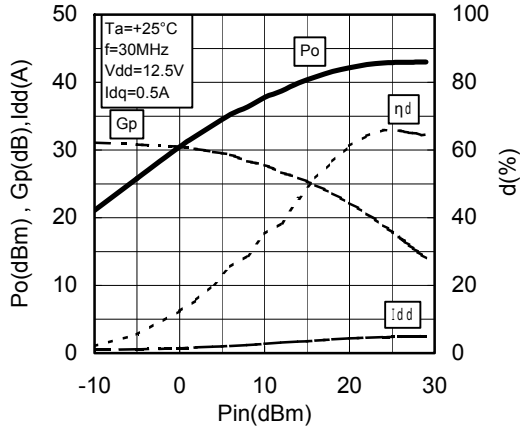

Pin-Po CHARACTERISTICS

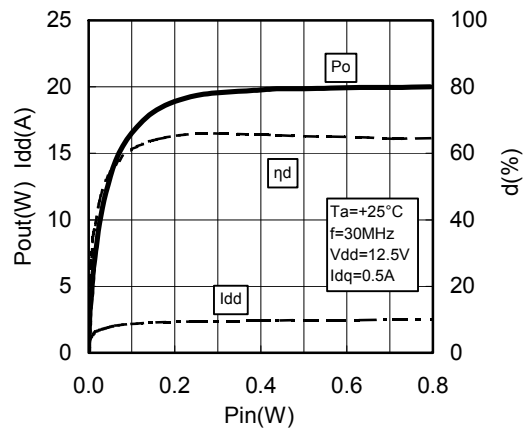

Vdd-Po CHARACTERISTICS

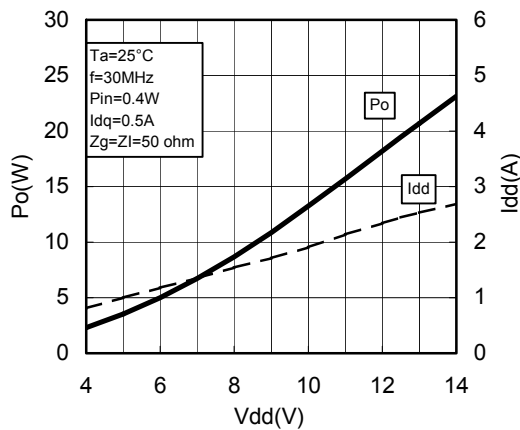

Vgs-Ids CHARACTERISTICS 2

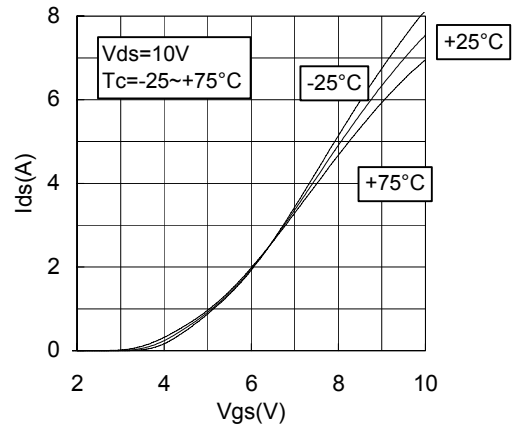

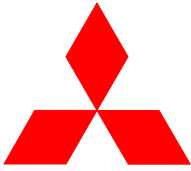

ELECTROSTATIC SENSITIVE DEVICE
OBSERVE HANDLING PRECAUTIONS

MITSUBISHI RF POWER MOS FET

RD16HHF1

RoHS Compliance, Silicon MOSFET Power Transistor 30MHz,16W

TEST CIRCUIT(f=30MHz)

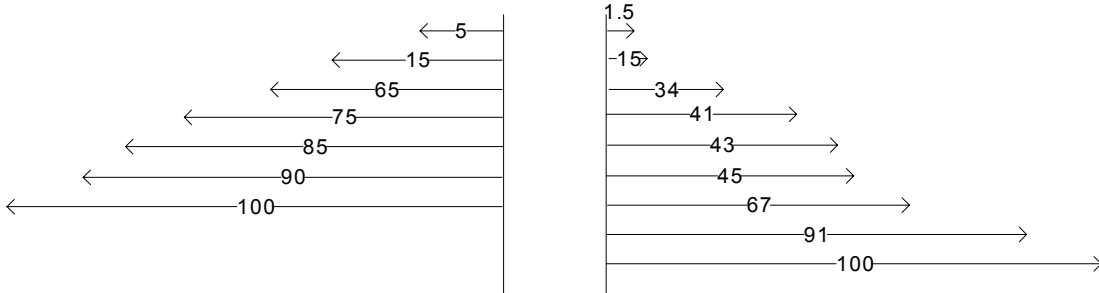
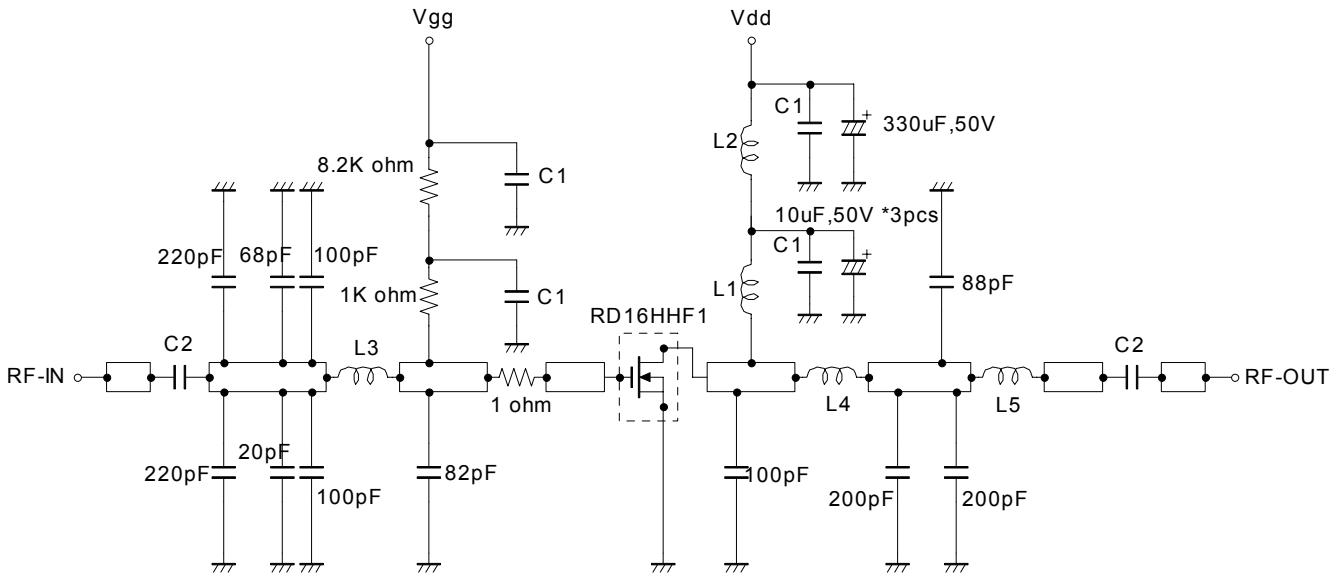

C1:100pF,0.022uF,0.1uF in parallel
C2:470pF*2 in parallel

- L1:10Turns,l.D8mm,D0.9mm copper wire
- L2:10Turns,l.D6mm,D1.6mm silver plated copper wire
- L3:9Turns,l.D5.6mm,D0.9mm copper wire
- L4:4Turns,l.D5.6mm,D0.9mm,P=0.5mm copper wire
- L5:5Turns,l.D5.6mm,D0.9mm,P=1mm copper wire

Dimensions:mm

Note:Board material-teflon substrate
micro strip line width=4.2mm/50 ohm,er:2.7,t=1.6mm

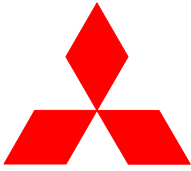

ELECTROSTATIC SENSITIVE DEVICE
OBSERVE HANDLING PRECAUTIONS

MITSUBISHI RF POWER MOS FET

RD16HHF1

RoHS Compliance, Silicon MOSFET Power Transistor 30MHz,16W

INPUT/OUTPUT IMPEDANCE VS.FREQUENCY CHARACTERISTICS

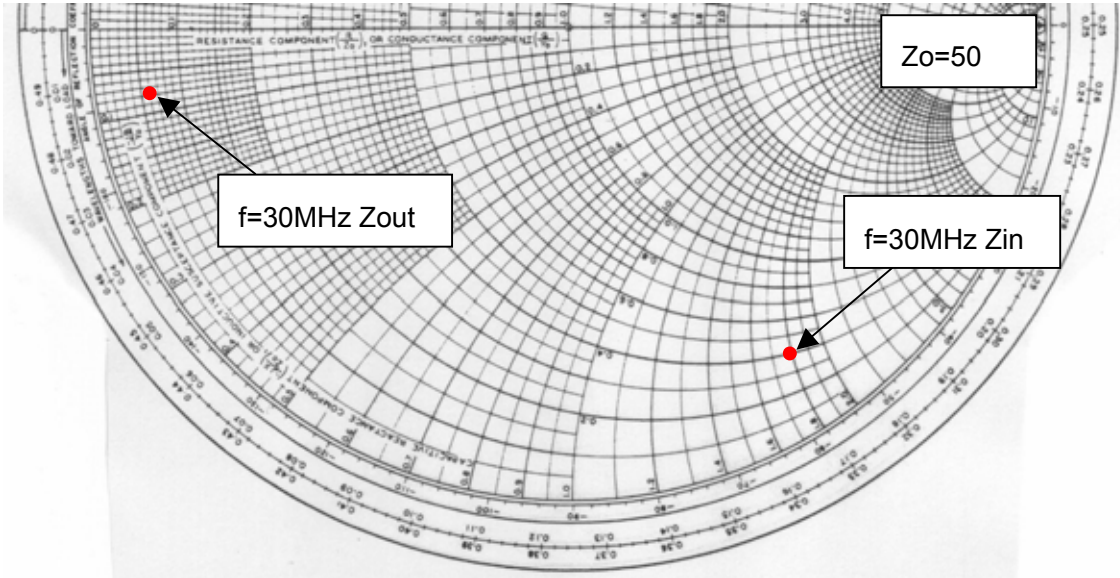

Zin , Zout

f (MHz)	Zin (ohm)	Zout (ohm)	Conditions
30	20.02-j89.42	2.99-j3.66	

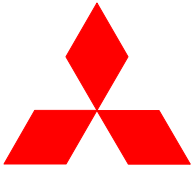

ELECTROSTATIC SENSITIVE DEVICE
OBSERVE HANDLING PRECAUTIONS

MITSUBISHI RF POWER MOS FET

RD16HHF1

RoHS Compliance, Silicon MOSFET Power Transistor 30MHz,16W

RD16HHF1 S-PARAMETER DATA (@Vdd=12.5V, Id=800mA)

Freq. [MHz]	S11		S21		S12		S22	
	(mag)	(ang)	(mag)	(ang)	(mag)	(ang)	(mag)	(ang)
10	0.928	-43.2	50.035	150.2	0.013	60.6	0.705	-44.6
30	0.761	-96.8	32.680	117.1	0.025	34.3	0.588	-92.6
50	0.676	-121.9	22.018	101.3	0.027	24.3	0.540	-116.9
100	0.650	-145.8	11.543	81.0	0.025	20.3	0.543	-138.4
150	0.679	-156.4	7.560	66.2	0.023	27.0	0.586	-147.1
200	0.709	-162.7	5.380	55.7	0.022	46.4	0.633	-153.2
250	0.742	-168.0	4.126	45.9	0.026	63.2	0.698	-158.1
300	0.775	-173.0	3.208	36.9	0.034	74.4	0.727	-163.2
350	0.801	-177.7	2.592	29.6	0.045	78.3	0.769	-168.0
400	0.826	177.7	2.133	22.6	0.056	78.4	0.805	-172.8
450	0.844	173.2	1.775	16.6	0.069	78.1	0.822	-176.8
500	0.861	169.0	1.509	11.3	0.081	75.3	0.851	178.9
550	0.874	164.8	1.283	5.9	0.093	73.1	0.867	174.7
600	0.884	160.7	1.114	2.1	0.104	69.8	0.877	170.9
650	0.892	156.9	0.974	-1.9	0.117	67.2	0.894	166.9
700	0.900	153.0	0.855	-5.3	0.129	63.7	0.897	163.4
750	0.903	149.1	0.759	-8.4	0.140	60.6	0.904	159.6
800	0.908	145.5	0.678	-11.3	0.150	56.8	0.914	155.9
850	0.912	141.7	0.614	-13.5	0.161	53.8	0.915	152.9
900	0.912	137.9	0.559	-15.3	0.172	50.4	0.917	149.0
950	0.913	134.3	0.509	-17.3	0.180	47.1	0.922	145.4
1000	0.913	130.7	0.467	-17.9	0.190	43.6	0.920	142.4



ELECTROSTATIC SENSITIVE DEVICE
OBSERVE HANDLING PRECAUTIONS

MITSUBISHI RF POWER MOS FET

RD16HHF1

RoHS Compliance, Silicon MOSFET Power Transistor 30MHz,16W

—————Keep safety first in your circuit designs! —————

Mitsubishi Electric Corporation puts the maximum effort into making semiconductor products better and more reliable, but there is always the possibility that trouble may occur with them. Trouble with semiconductors may lead to personal injury, fire or property damage. Remember to give due consideration to safety when making your circuit designs, with appropriate measures such as (i) placement of substitutive, auxiliary circuits, (ii) use of non-flammable material or (iii) prevention against any malfunction or mishap.

————— **warning !** —————

Do not use the device at the exceeded the maximum rating condition. In case of plastic molded devices, the exceeded maximum rating condition may cause blowout, smoldering or catch fire of the molding resin due to extreme short current flow between the drain and the source of the device. These results causes in fire or injury.